

Montageanleitung

Rota LED

Installation Instruction

Rota LED

Instructions de Montage

Rota LED

Monteringsanvisning

Rota LED

Montagehandleiding

Rota LED

Instrucciones de Montaje

Rota LED

Istruzioni di Montaggio

Rota LED

Asennusohje

Rota LED

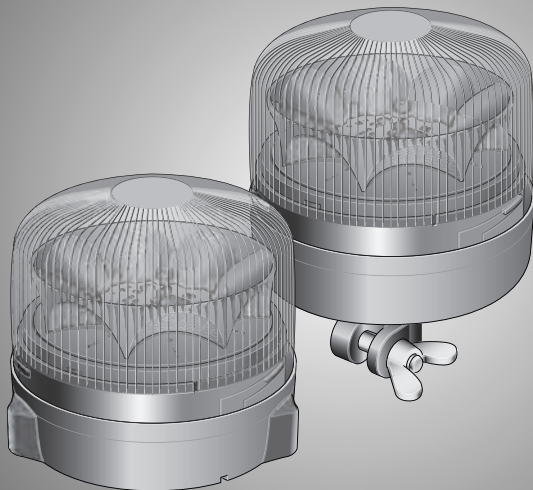

DE Technische Änderungen vorbehalten

EN Subject to alteration without notice

FR Sous réserve de modifications techniques

SV Vi reserverar oss för tekniska ändringar

NL Technische wijzigingen voorbehouden

ES Reservadas modificaciones técnicas

IT Con riserva di modifiche tecniche

FI Oikeus teknisiin muutoksiin pidätetään

Lieferumfang
Kit Includes
Fourniture

Leveransomfattning
Inhoud Set
Volumen del Suministro

Dotazione di Fornitura
Osaluettelo



Rota LED FL
2RL 010 979-011

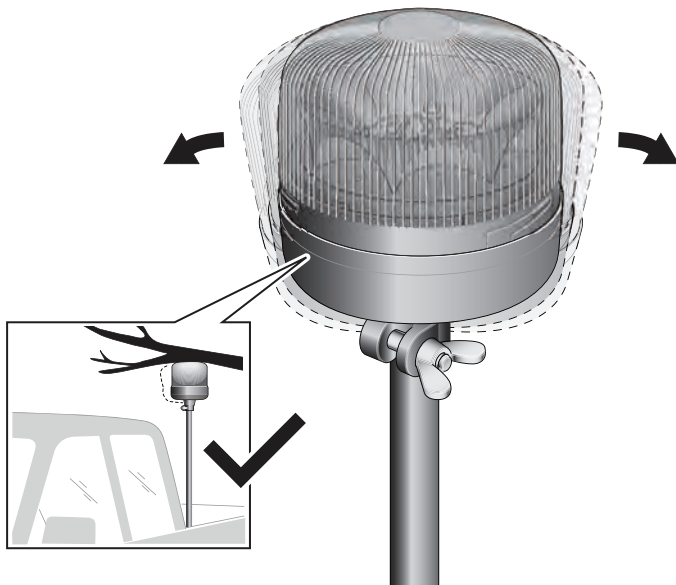

Lieferumfang
Kit Includes
Fourniture

Leveransomfattning
Inhoud Set
Volumen del Suministro

Dotazione di Fornitura
Osaluettelo



Rota LED F
2RL 010 979-001

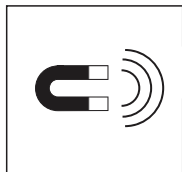

Rota LED M
2RL 010 979-021

Zubehör
Accessories
Accessories

Tillbehör
Toebehoren
Accessorios

Accessori
Lisätarvikkeet



1A 8JS 711 683-831



8KW 732 580-003

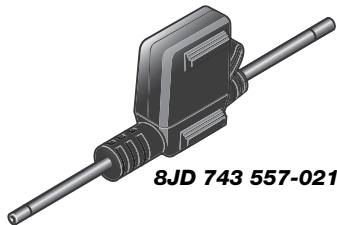

8JD 743 557-021



9EL 181 506-001

Benötigte Montagewerkzeuge
Installation tools required
Outillage de montage requis

Nödvändiga monteringsverktyg
Benodigde montagewerktuigen
Herramientas de montaje necesarias

Attrezzi necessari per il montaggio
Tarvittavat asennustyökalut

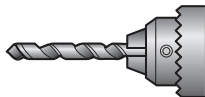

5 mm

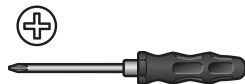

CLEANER

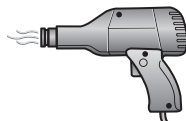
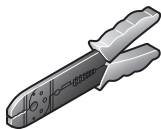
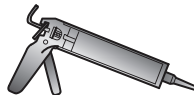

Montage
Mounting
Montage Général

Montering
Montage
Montaje

Montaggio
Asennus

7

I

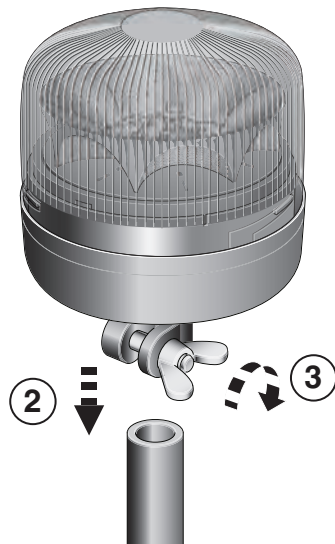
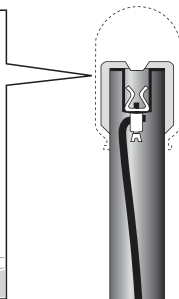
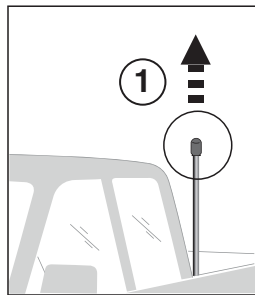
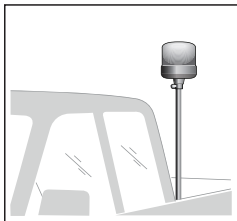

II

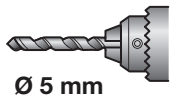
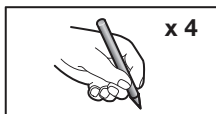
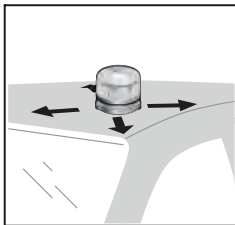

3 x PT Ø 4,2 mm



(-)
blau
bleu
bleu
blå
blauw
azul
blu
sininen

(+)
rot
red
rouge
röd
rood
rojo
rosso
punainen



max 1,5 Nm



II

(+)
rot
red
rouge
röd
rood
rojo
rosso
punainen

Ø 1,5 mm²

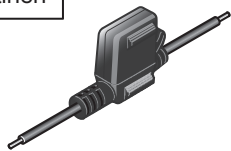
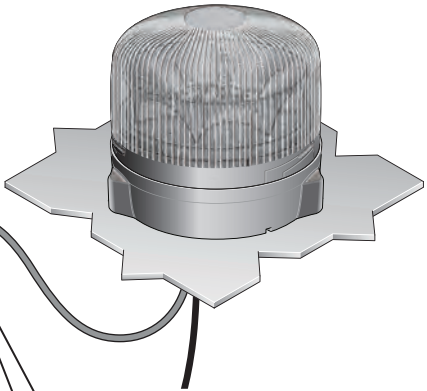

9

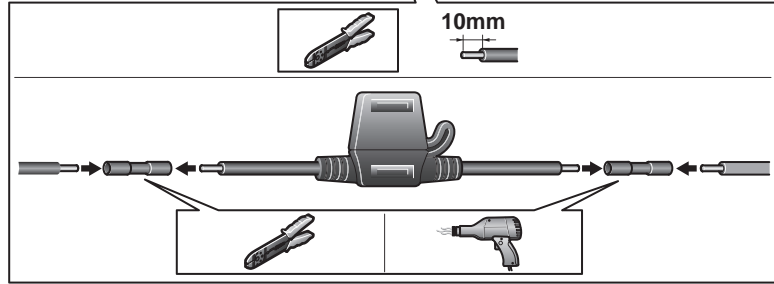



max. 120 km/h

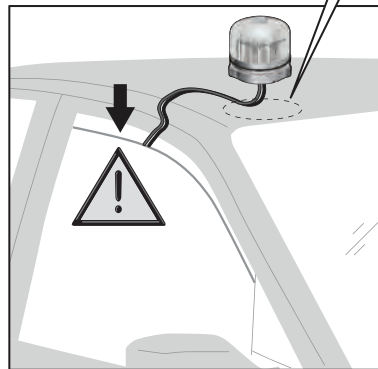
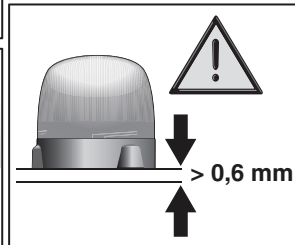
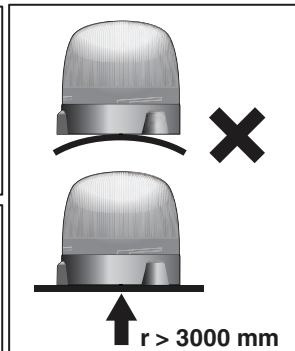
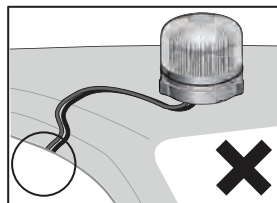
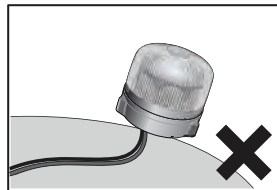
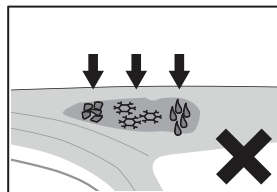

Lichthaubewechsel
Dome replacement
Changement du cabochon

Byte av ljushuv
Lichtkapvervanging
Recambio de la cubierta

Sostituzione della calotta
Kopan vaihto



DE Informationstext	13
EN Information Text	13
FR Texte d'information	14
SV Informationstext	14
NL Informatie tekst	15
ES Texto informativo	15
IT Informazioni	16
FI Ohjetekstit	16

Technische Daten

Typprüfung	Format: TA1 E1 003109
Nennspannung	12V/24V
Betriebsspannung	9-36V
Gesamtstromaufnahme	12V: ca. 0,7A 24V: ca. 0,4A
Entstörklasse	VDE 00879, Entstörgrad 3
Leistungsaufnahme	12V: ca. 8W 24V: ca. 10W
Lichthaube	PC
Gebrauchslage	stehend
Schutzart	IP5KX, IPX4K, IPX9K
Temperaturbereich	minus 40°C bis plus 60°C
Verpolschutz	ja
Gehäuse	EPDM
Entstörklasse	e1 Genehmigung nach 72/245 EWG in der Fassung 2006/28 EG.

Technical Data

Type approval:	Format: TA1 E1 003109
Rated voltage	12V/24V
Operating voltage	9-36V
Total current consumption	12V: approx. 0.7A 24V: approx. 0.4A
Interference suppression class	VDE 00879, Suppression level 3
Power consumption	12V: approx. 8W 24V: approx. 10W
Dome	PC
Operating position	Upright
Protective rating	IP5KX, IPX4K, IPX9K
Temperature range	minus 40°C to plus 60°C
Inverse polarity protection	yes
Housing	EPDM
Interference suppression class	e1 approval according to 72/245/EC in the version 2006/28/EC.

Caractéristiques techniques

Homologation:	Format: TA1 E1 003109
Tension nominale	12V/24V
Tension de service	9-36V
Courant total absorbé	12V: env. 0,7 A 24V: env. 0,4 A
Classe de déparasitage	VDE 00879, Degré de déparasitage 3
Puissance absorbée	12V: env. 8W 24V: env. 0,4A
Cabochoon	PC
Position d'utilisation	debout
Indice de protection	IP5KX, IPX4K, IPX9K
Plage de température	moins 40°C à plus 60°C
Protection contre les inversions de polarité	oui
Boîtier	EPDM
Classe de déparasitage	Autorisation e1 selon 72/245 CEE dans la version 2006/28 CE.

Tekniska data

Typprovning:	Format: TA1 E1 003109
Märkspänning	12V/24V
Driftsspänning	9-36V
Total strömuttagning	12V: ca. 0,7 A 24V: ca. 0,4 A
Avstörningsklass	VDE 00879, avstörningsgrad 3
Effektförbrukning	12V: ca. 8W 24V: ca. 10W
Ljushuv	PC
Användningsläge	Stående
Kapslingstyp	IP5KX, IPX4K, IPX9K
Temperaturområde	minus 40°C till plus 60°C
Polomkastnings-skydd	ja
Hus	EPDM
Avstörningsklass	e1 godkännande enl. 72/245 EWG i version 2006/28 EG.

Technische gegevens	
Typekeuring	Formaat: TA1 E1 003109
Nominale spanning	12V/24V
Bedrijfsspanning	9-36V
Totale stroomverbruik	12V: ca. 0,7A 24V: ca. 0,4A
Ontstoringsklasse	VDE 00879, ontstoringsniveau
Vermogensopname	12V: ca. 8W 24V: ca. 10W
Lichtkap	PC
Toepassingsstand	staand
Beschermsoort	IP5KX, IPX4K, IPX9K
Temperatuurbereik	min 40°C tot plus 60°C
Poolinversie-beveiliging	ja
Behuizing	EPDM
Ontstoringsklasse	e1 goedkeuring conform 72/245 EWG in uitgave 2006/28 EG.

Datos técnicos	
Formato de la homologación de tipo:	TA1 E1 003109
Tensión nominal	12V/24V
Tensión de servicio	9-36V
Consumo de corriente total	12V: aprox. 0,7A 24V: aprox. 0,4A
Clase de supr. de interf.	VDE 00879, grado de supr. de interf. 3
Consumo de potencia	12V: aprox. 8W 24V: aprox. 10W
Cubierta	PC
Posición de empleo	de pie
Tipo de protección	IP5KX, IPX4K, IPX9K
Intervalo de temperatura	- 40°C a + 60°C
Protección ante inv. de polaridad	sí
Carcasa	EPDM
Clase de supr. de interf.	e1 autorización conforme a 72/245 CEE en la versión 2006/28 CE.

Dati tecnici

Omologazione:	Formato: TA1 E1 003109
Tensione nominale	12V/24V
Tensione di esercizio	9-36V
Assorbimento complessivo di corrente	12V: ca. 0,7A 24V: ca. 0,4A
Classe di soppressione delle interferenze	VDE 00879, grado di soppressione delle interferenze: 3
Potenza assorbita	12V: ca. 8W 24V: ca. 10W
Calotta	PC
Posizione d'impiego	Eretta
Classi di protezione	IP5KX, IPX4K, IPX9K
Intervallo di temperatura	Da meno 40°C a più 60°C
Protezione contro l'inversione della polarità	Sì
Alloggiamento	EPDM
Classe di soppressione delle interferenze	Autorizzazione e1 secondo 72/245 CEE nella versione 2006/28 CE.

Tekniset tiedot

Tyypihyväksyntä, muoto:	TA1 E1 003109
Nimellisjännite	12V/24V
Käyttöjännite	9-36V
Kokonaisvirrankulutus	12V noin 0,7A 24V noin 0,4A
EMC-radiohäiriösuojaluokka	VDE 00879, EMC-radiohäiriösuojataseo 3
Tehonotto	12V noin 8W 24V noin 10W
Koppa	PC
Käyttöasento	pystyasento
Suojaluokka	IP5KX, IPX4K, IPX9K
Lämpötila-alue	-40°C - +60°C
Navoitussuoja	kyllä
Kotelo	EPDM (eteenipropeenikumi)
EMC-radiohäiriösuojaluokka	e1 hyväksyntä 72/245 EEC mukaan, muodossa 2006/28 EY

DE Beleuchtungsanlage auf einwandfreie Funktion hin prüfen

EN Check that the lighting system is working perfectly

FR Contrôler le bon fonctionnement de l'installation d'éclairage

SV Kontrollera att ljussystemet fungerar felfritt

NL Controleer of de verlichting goed functioneert

ES Comprobar que el sistema de iluminación funciona impecablemente

IT Controllare la perfetta funzionalità dell'impianto di illuminazione

FI Tarkasta valaistusjärjestelmän toiminta

- DE** Bei Fragen oder Einbauproblemen, rufen Sie bitte den HELLA Kundendienst, Großhändler an oder wenden Sie sich an Ihre Werkstatt.
- EN** If you have questions or installation problems, please call the HELLA Service, wholesaler, or turn to your garage.
- FR** Pour toutes questions ou problèmes de montage, merci de contacter le service après-vente HELLA, votre distributeur ou votre garage.
- SV** Vid frågor eller monteringsproblem, kontakta Hella kundtjänst, återförsäljaren eller din verkstad.
- NL** In geval van vragen of montageproblemen verzoeken wij u contact met de HELLA-klantenservice, de groothandel of uw dealer op te nemen.
- ES** En caso de dudas o problemas de montaje, por favor, llame al Servicio postventa de Hella o al mayorista, o bien diríjase a su taller.
- IT** Per qualsiasi domanda o problemi di montaggio si prega di contattare il servizio assistenza o il proprio grossista HELLA oppure di rivolgersi alla propria officina.
- FI** Jos sinulla on kysymyksiä tai asennusongelmia, soita HELLA-asiakaspalvelulle tai tukkuliikkeelle tai käänny korjaamon puoleen.

